

**SPEC SHEET: T6XPSM-PERF**

**6' STANDARD PERFORATED PICNIC TABLE** *surface mount*

**Wt. 285 lbs**



*top view*

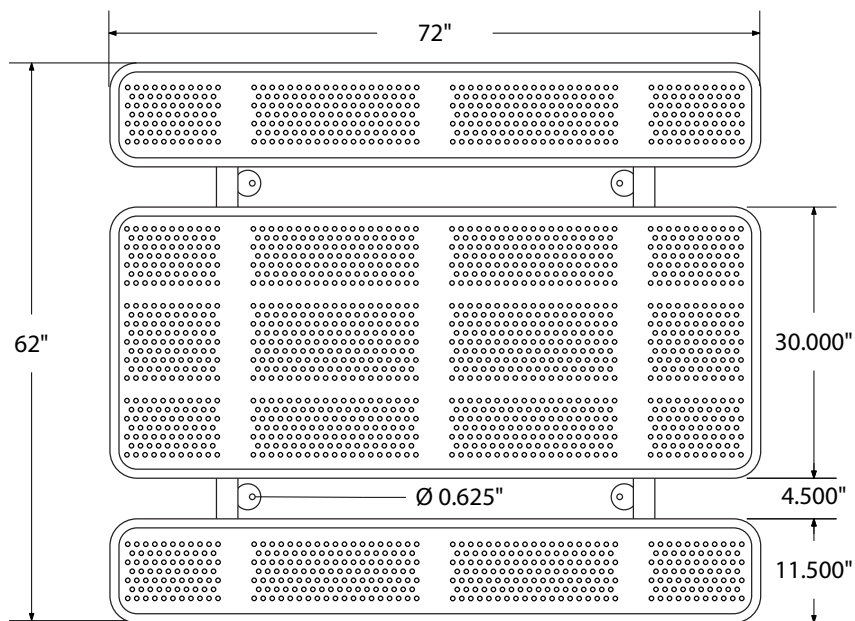

*front view*

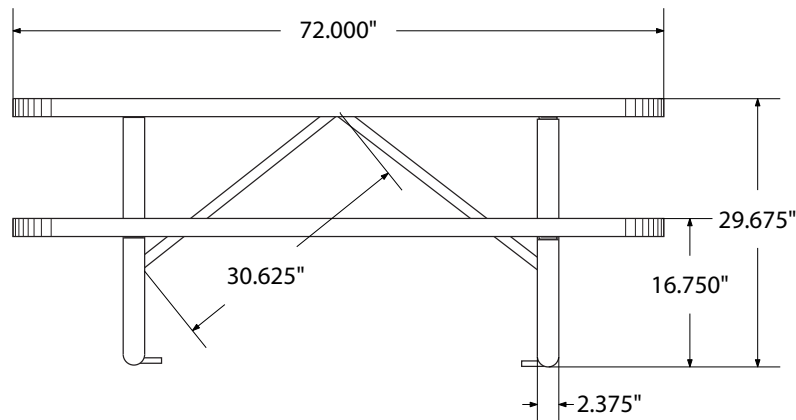

## side view

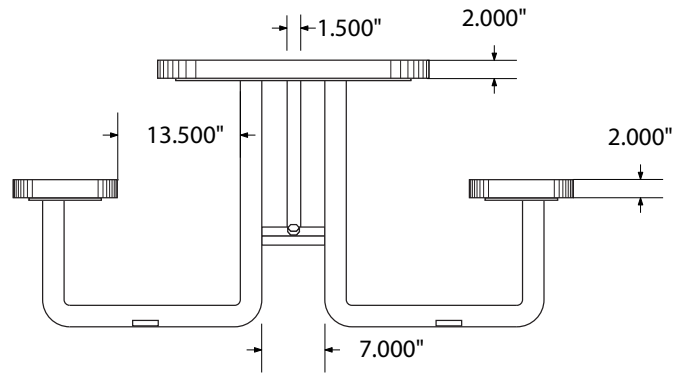

## product details

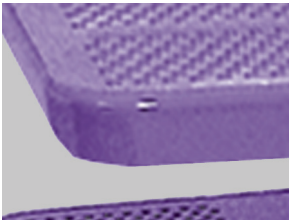

### Coated Surfaces:

- Thermoplastic coated
- Copolymer-based, environmentally safe
- Does not fade, crack, peel or warp
- Applied at a thickness of 25-30 mils.
- 5 Year warranty on coating



### Construction:

- Seats and tops - 11 gauge steel
- 2 3/8" tubular understructure
- Understructure - galvanized steel
- Understructure finish - black polyester powder coated
- Nuts, washers and bolts - galvanized steel

## mounting types

P = Portable : no mount

SM = Surface Mount:  
concrete anchors  
through discs welded  
to legs

IG= In-Ground:  
J-rods set in concrete  
through discs welded  
to legs

