

SPEC SHEET: 2BK5P-SM

43 7/8" THERMOPLASTIC WAVE RACK 2 3/8" DIA *surface mount*

Wt. 85 lbs

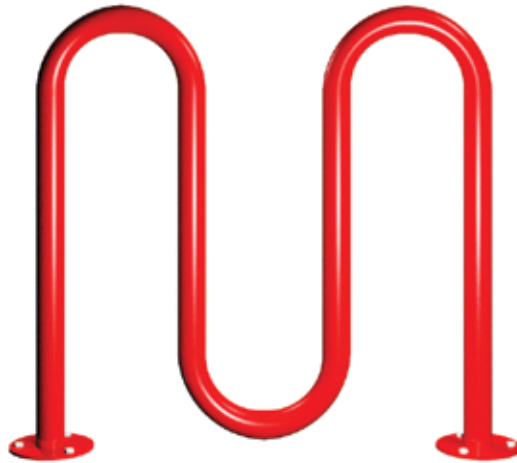

top view

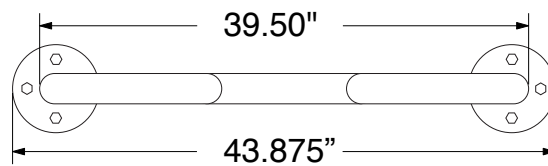

front view

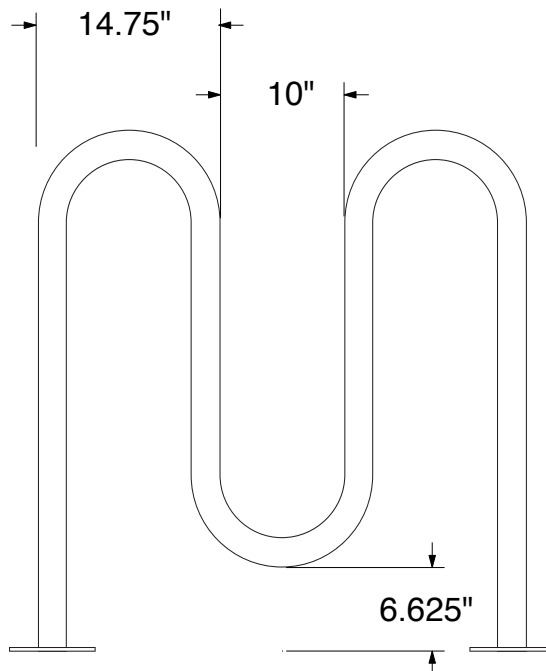

side view

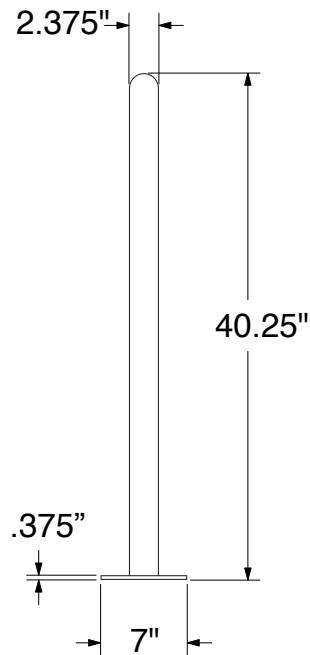

product finish



The functional surfaces of our furniture are covered in a copolymer-based thermoplastic powder coating. Thermoplastic is environmentally safe, the coating will never fade, crack, peel, warp, or discolor for the life of the product. Thermoplastic is applied at a thickness of 25-30 mils.

mounting types

SM = Surface Mount:
concrete anchors
through discs welded
to legs

IG= In-Ground:
extra long tubes

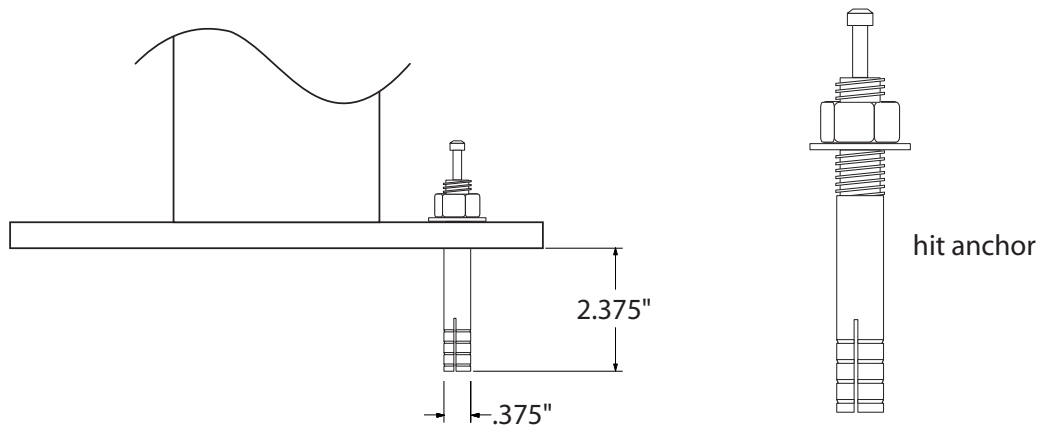

SURFACE MOUNT