

**SPEC SHEET: RFP5-PERF**

**5' PERSONALIZED PERF BENCH SURFACE MOUNT**

**Wt. 265 lbs**



**top view**

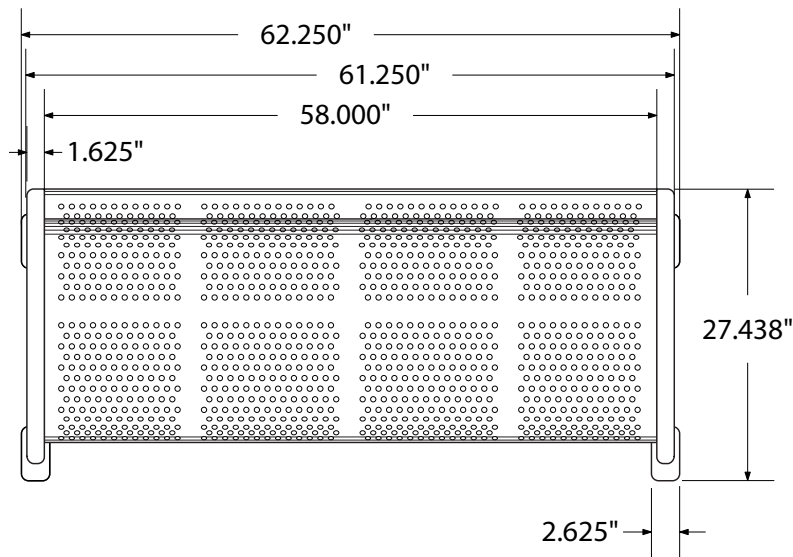

**front view**

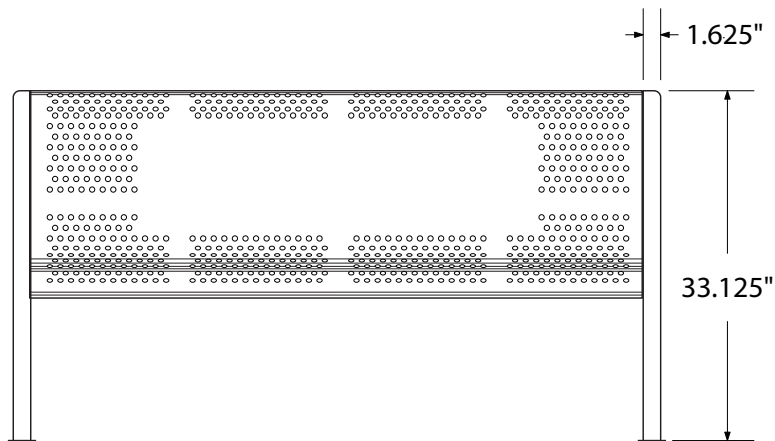

## side view

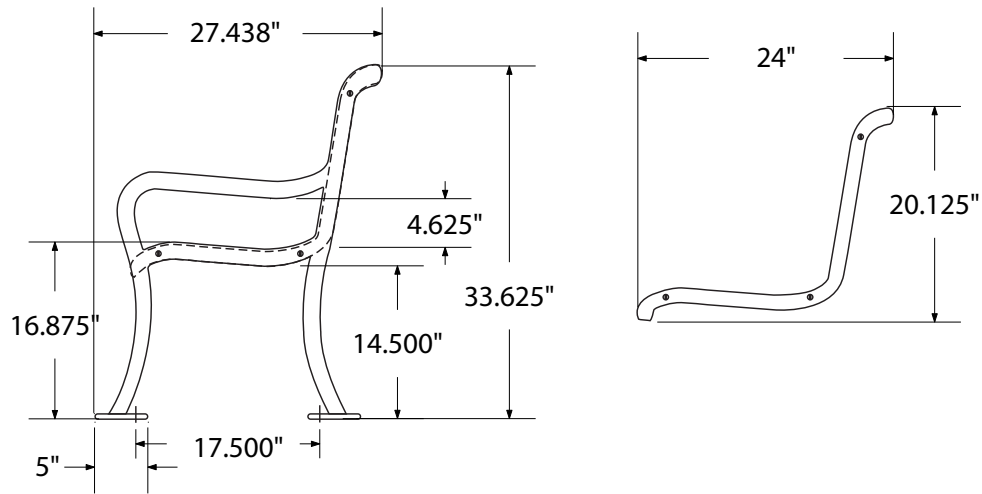

## product finish

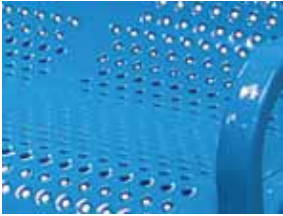

The functional surfaces of our furniture are covered in a copolymer-based thermoplastic powder coating. Thermoplastic is environmentally safe, the coating will never fade, crack, peel, warp, or discolor for the life of the product. Thermoplastic is applied at a thickness of 25-30 mils.

## mounting types

P = Portable : no mount

SM = Surface Mount:  
concrete anchors  
through discs welded  
to legs

IG= In-Ground:  
J-rods set in concrete  
through discs welded  
to legs

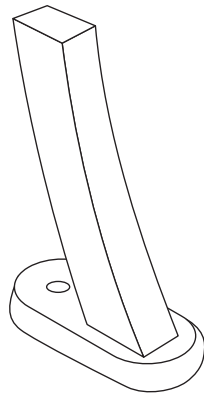

PORTABLE

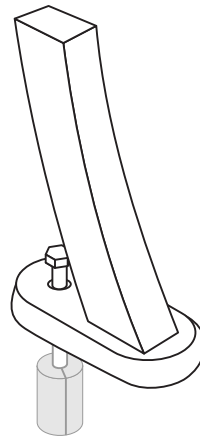

SURFACE MOUNT

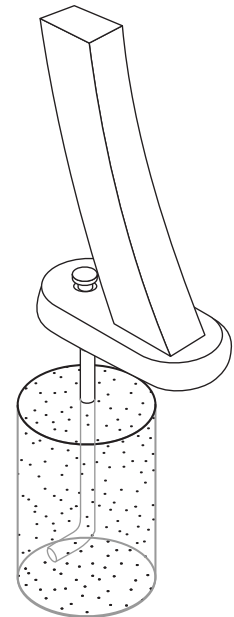

IN-GROUND