

**SPEC SHEET: OG8**

**8' OGLETHORPE BENCH** *PORTABLE*

**Wt. 360 lbs**



*top view*

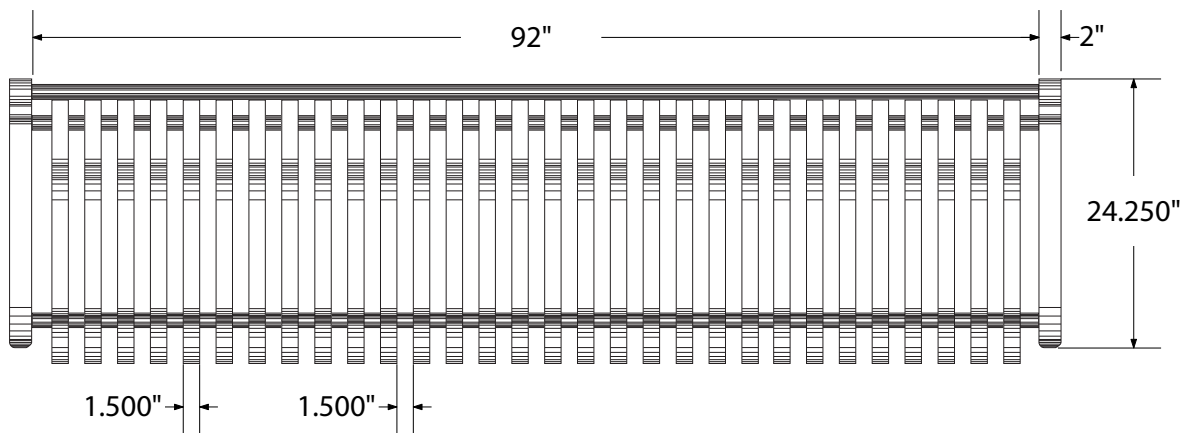

*front view*

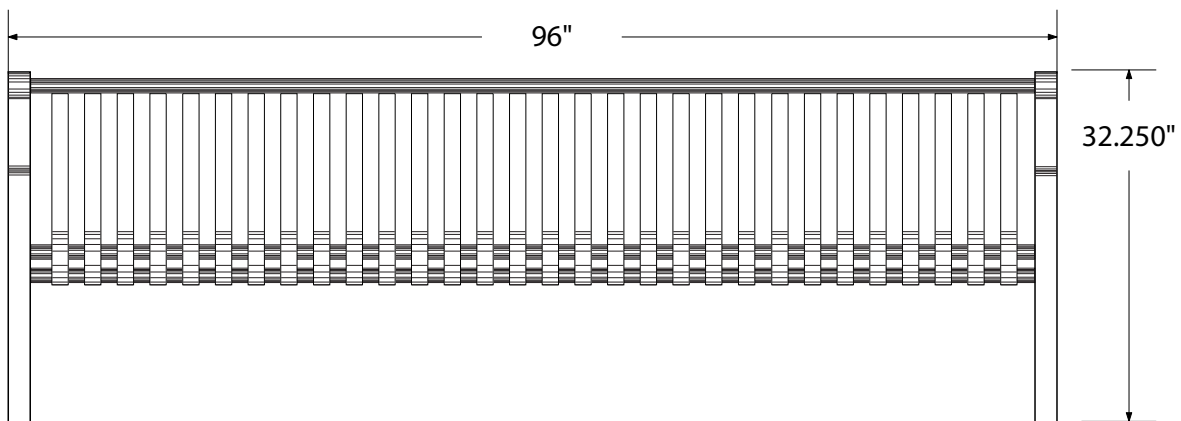

## side view

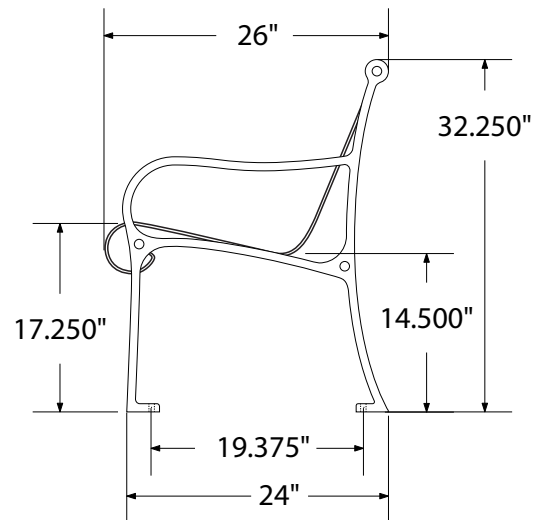

## product finish

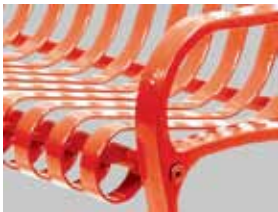

The functional surfaces of our furniture are covered in a copolymer-based thermoplastic powder coating. Thermoplastic is environmentally safe, the coating will never fade, crack, peel, warp, or discolor for the life of the product. Thermoplastic is applied at a thickness of 25-30 mils.

## mounting types

P = Portable : no mount

SM = Surface Mount:  
concrete anchors  
through discs welded  
to legs

IG= In-Ground:  
J-rods set in concrete  
through discs welded  
to legs

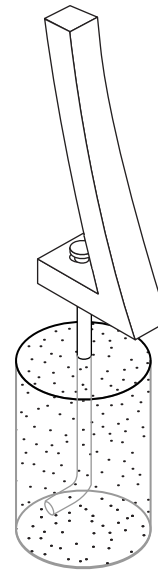
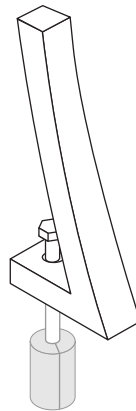
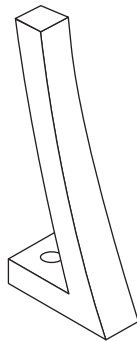

portable

surface mount

in-ground