

**SPEC SHEET: ULRF96-PERF**

**8' U-LEG PERFORATED BENCH SURFACE MOUNT**

**Wt. 280 lbs**



*top view*

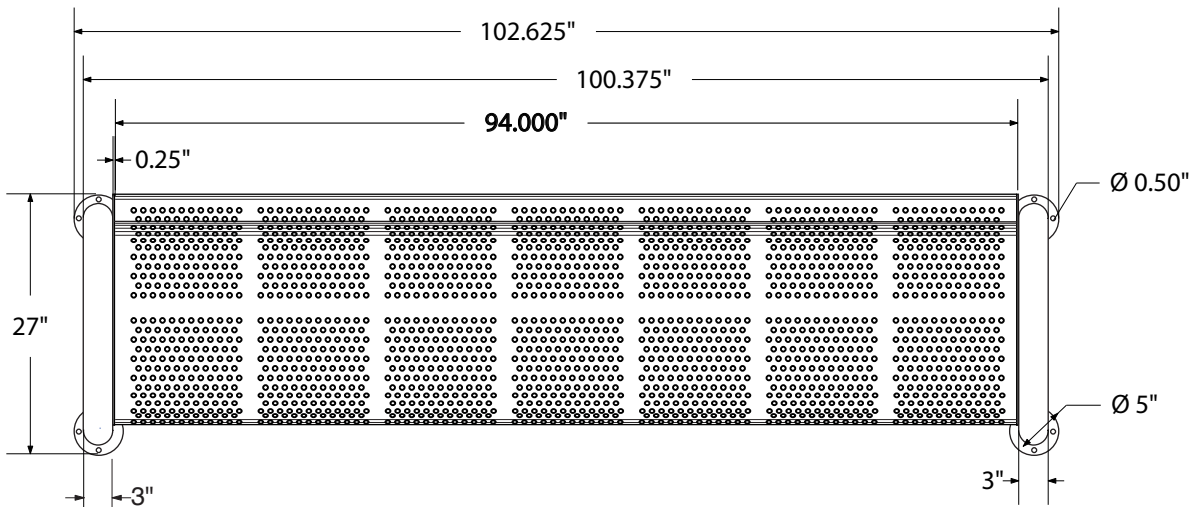

*front / back view*

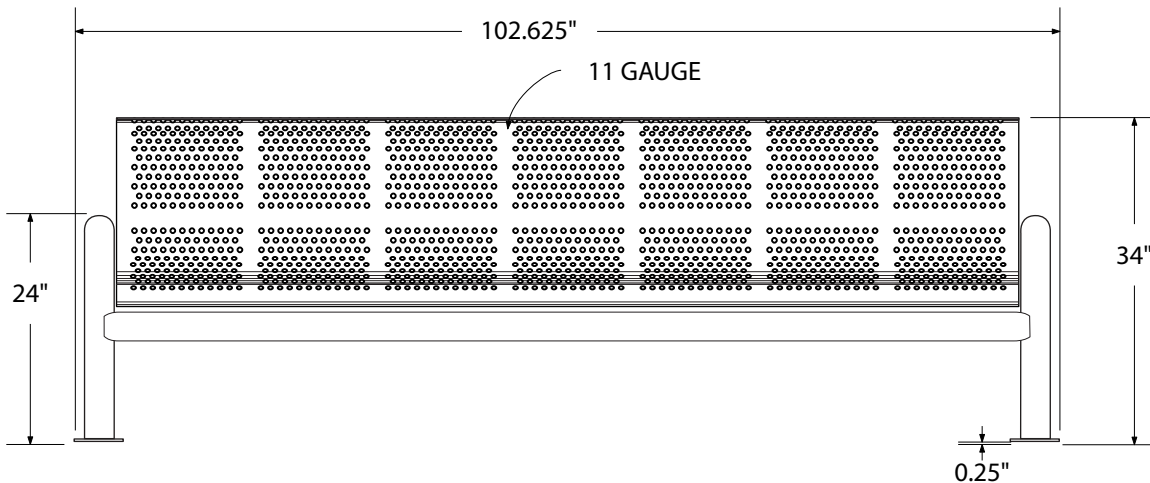

## side view

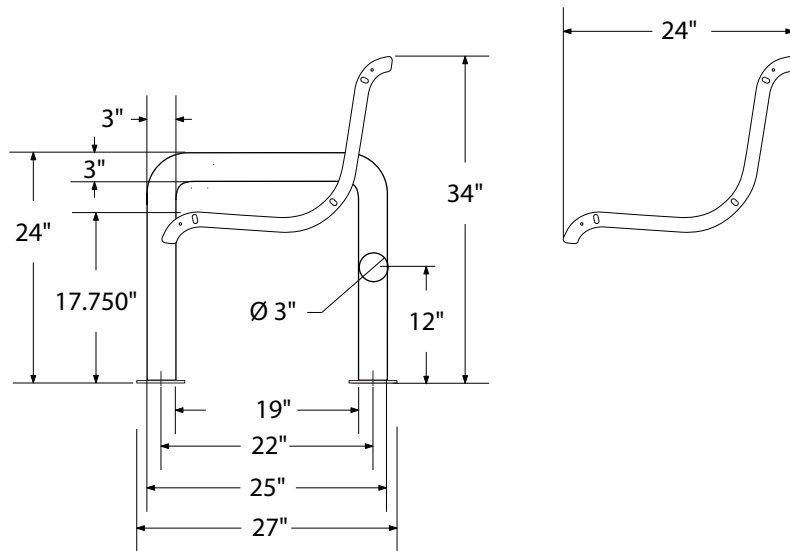

## product finish



The functional surfaces of our furniture are covered in a copolymer-based thermoplastic powder coating. Thermoplastic is environmentally safe, the coating will never fade, crack, peel, warp, or discolor for the life of the product. Thermoplastic is applied at a thickness of 25-30 mils.

## mounting types

P = Portable : no mount

SM = Surface Mount:  
concrete anchors  
through discs welded  
to legs

IG= In-Ground:  
extra long legs

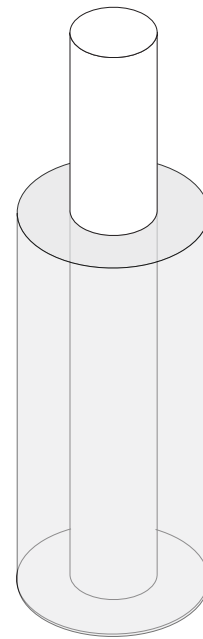
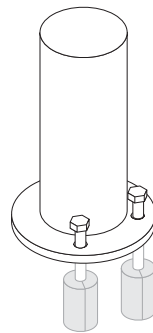
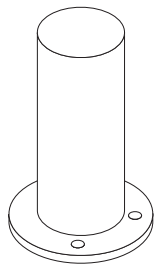

PORTABLE

SURFACE MOUNT

IN-GROUND