

SPEC SHEET: RFR72

6' RING BENCH SURFACE MOUNT

Wt. 260 lbs

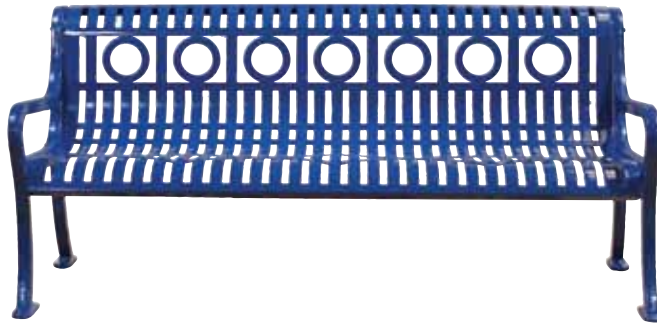

top view

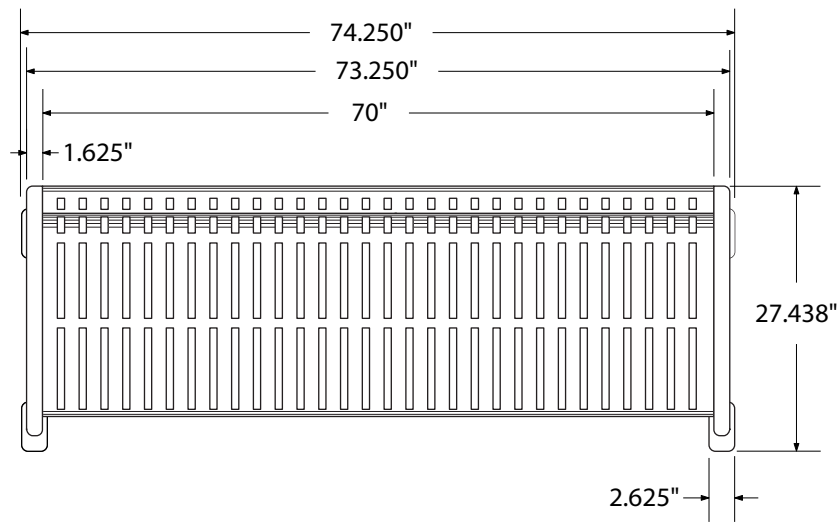

front view

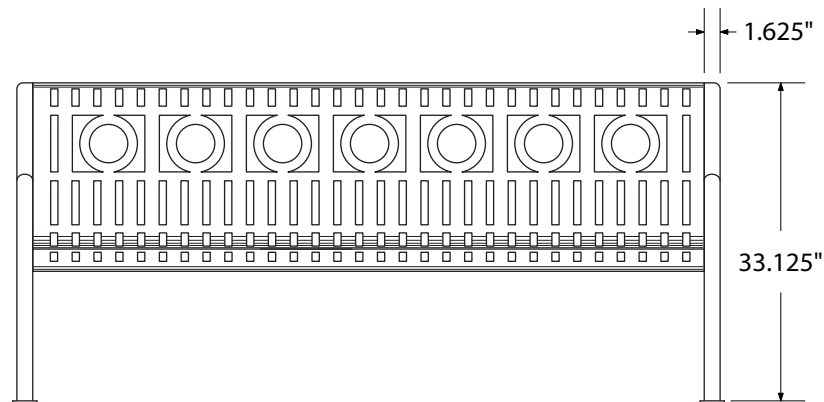

side view

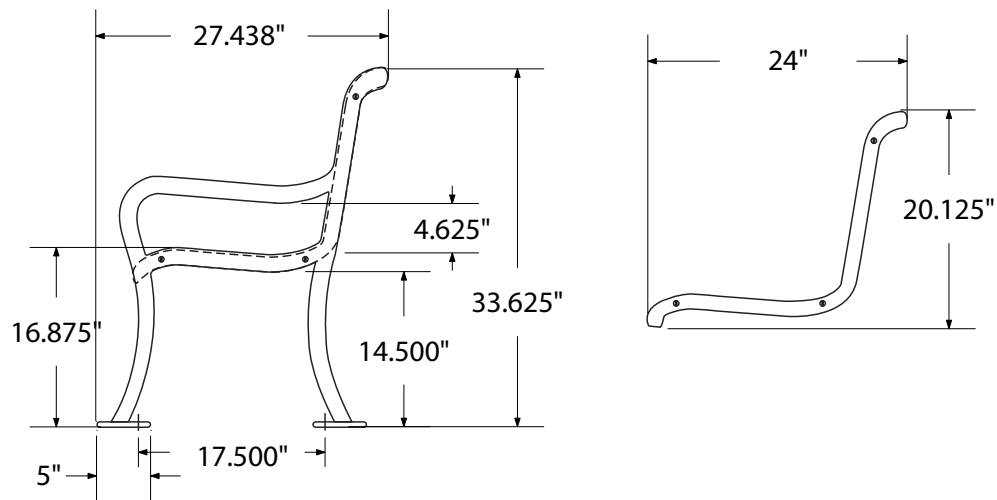

product finish

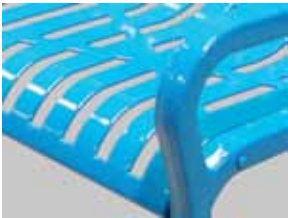

The functional surfaces of our furniture are covered in a copolymer-based thermoplastic powder coating. Thermoplastic is environmentally safe, the coating will never fade, crack, peel, warp, or discolor for the life of the product. Thermoplastic is applied at a thickness of 25-30 mils.

mounting types

P = Portable : no mount

SM = Surface Mount:
concrete anchors
through discs welded
to legs

IG= In-Ground:
J-rods set in concrete
through discs welded
to legs

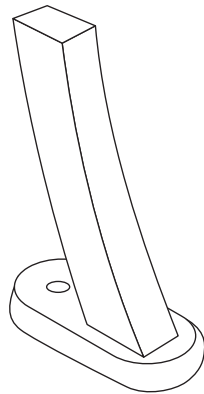

PORTABLE

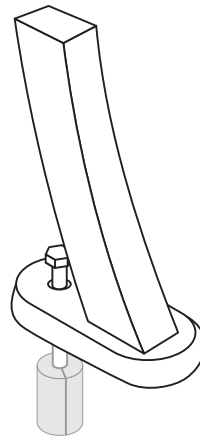

SURFACE MOUNT

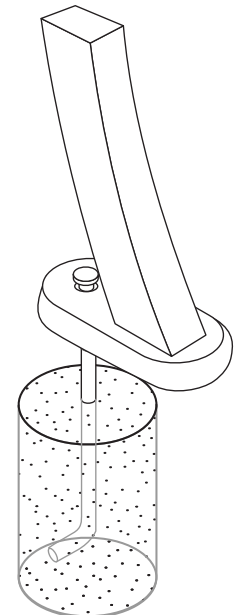

IN-GROUND