

SPEC SHEET: B6XPLIG

6' STANDARD EXP PLAYER'S BENCH WITHOUT BACK *IN-GROUND* **Wt. 81 lbs**

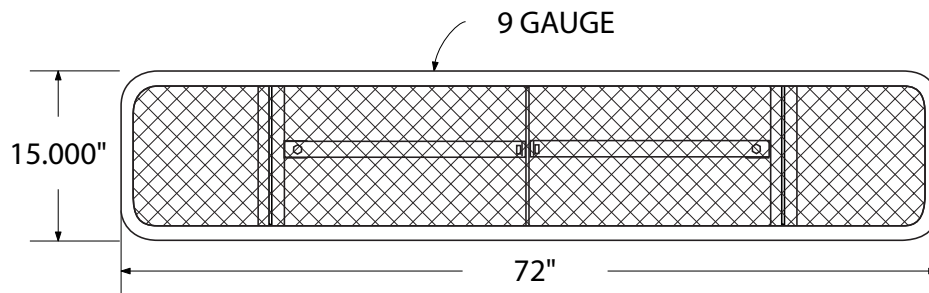

top view



front

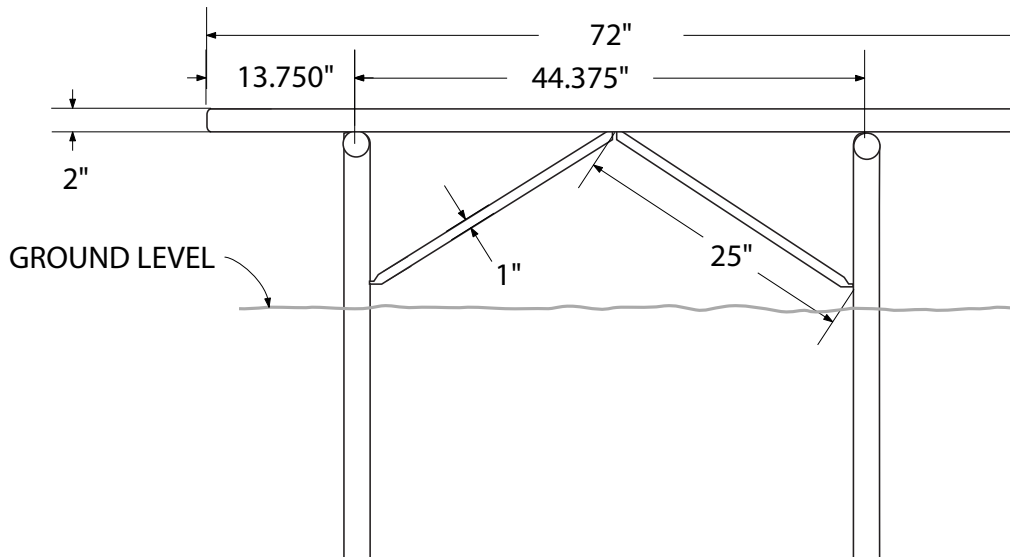

side view

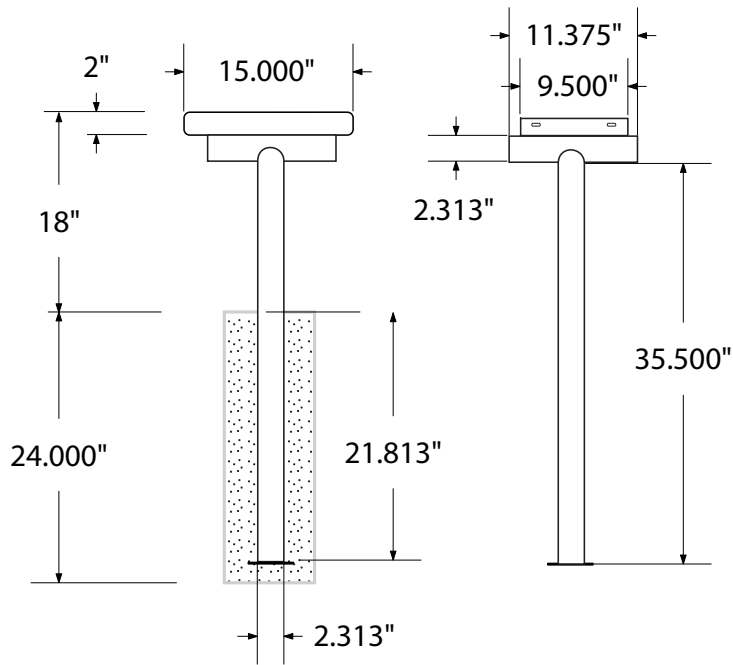

product finish



The functional surfaces of our furniture are covered in a copolymer-based thermoplastic powder coating. Thermoplastic is environmentally safe, the coating will never fade, crack, peel, warp, or discolor for the life of the product. Thermoplastic is applied at a thickness of 25-30 mils.



Tubular legs and understructure parts are made from galvanized steel and are finished with black polyester powder coating.

mounting types

P = Portable : no mount

SM = Surface Mount:
concrete anchors
through discs welded
to legs

IG= In-Ground:
J-rods set in concrete
through discs welded
to legs

IG= In-Ground
2 nd option extra
long legs

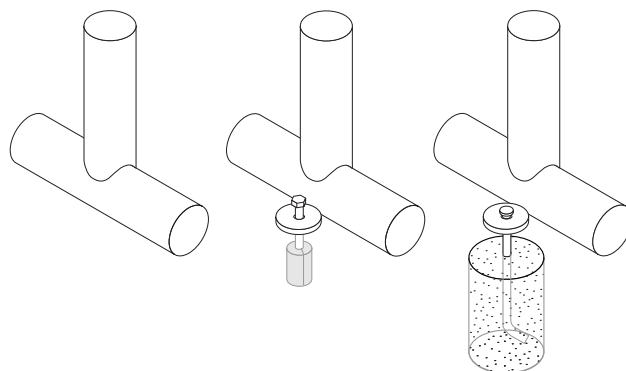

PORTABLE

SURFACE MOUNT

IN-GROUND

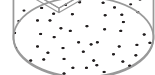

IN-GROUND