

SQUARE UMBRELLA SHADE

10' x 10' x 8'

MODEL #:  
 SU101008IG (With Glide Elbows)  
 SD101008IN (Without Glide Elbows)

REF.#	PART DESCRIPTION	QTY.
1	Ø3.5" Column - Embedded	1
2	Ø3.5" Crown - With Four Sockets	1
3	Ø2.5" Rafter - Swaged With Bracket	4
4	Strut - Rigid Fixed	4
5	Fabric - With Cable Insert	1
6	Frame Hardware Kit	1

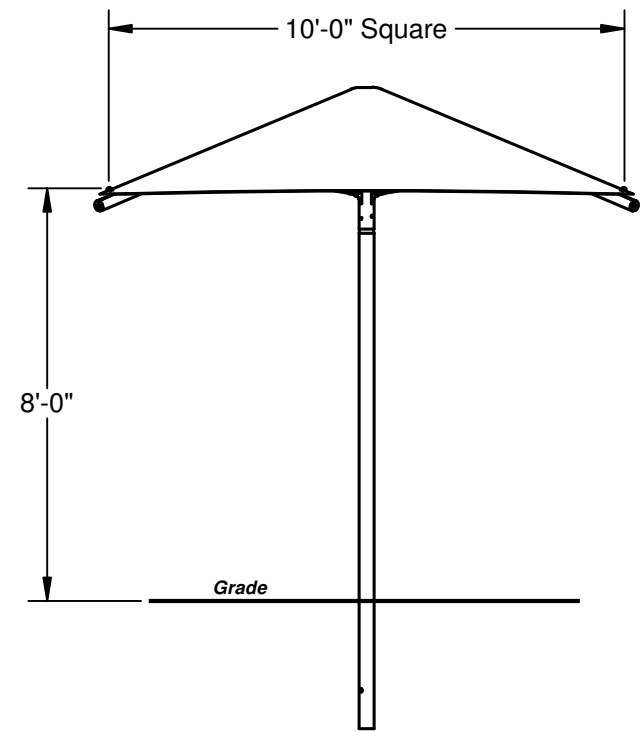

**ELEVATION VIEW**

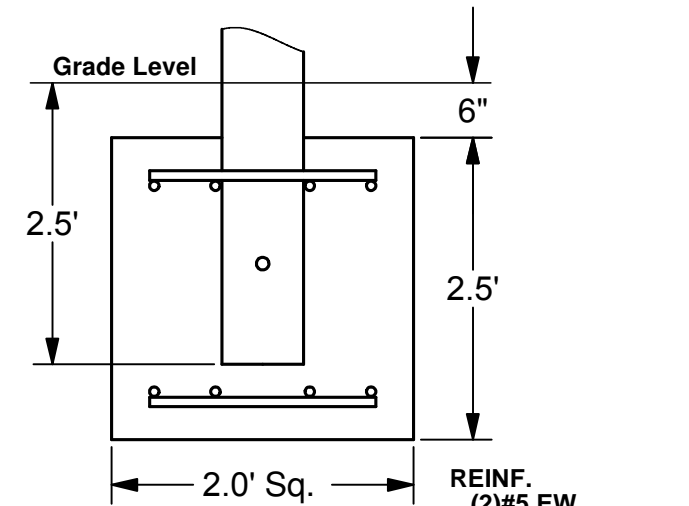

**FOOTING DETAIL**

\*Footing design based on 1500 PSF soil bearing pressure.



**SUPERIOR**  
 RECREATIONAL PRODUCTS

1050 Columbia Drive  
 Carrollton, Georgia  
 1.888.829.8997 | 770.834.2764 (f)

*These drawings are for reference only and should not be used as construction details. Materials, fasteners, and foundations are subject to change if professionally sealed engineering drawings are required. Designed for 93 MPH Basic Wind Speed.*