

SPEC SHEET: T6XPSM

6' STD EXP PICNIC TABLE *surface mount*

Wt. 215 lbs



top view

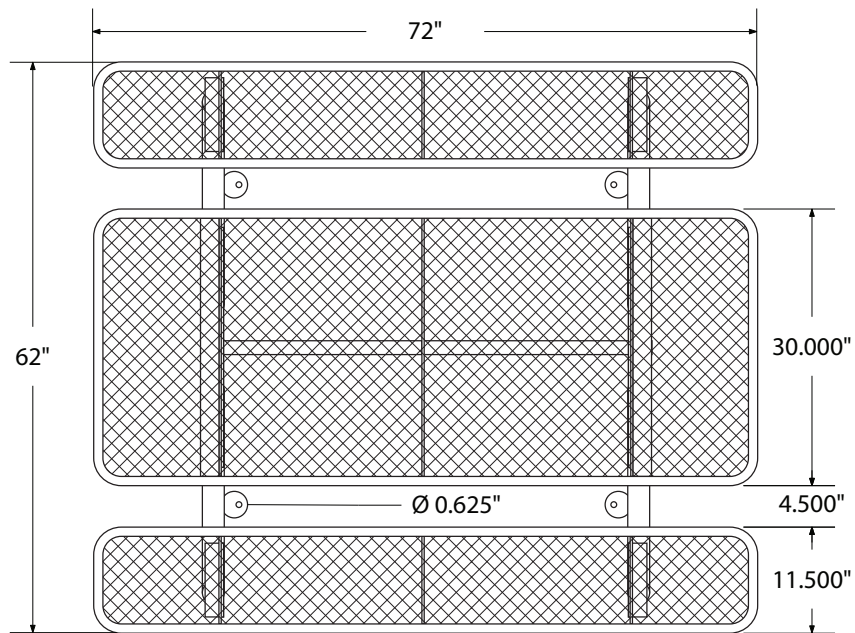

front view

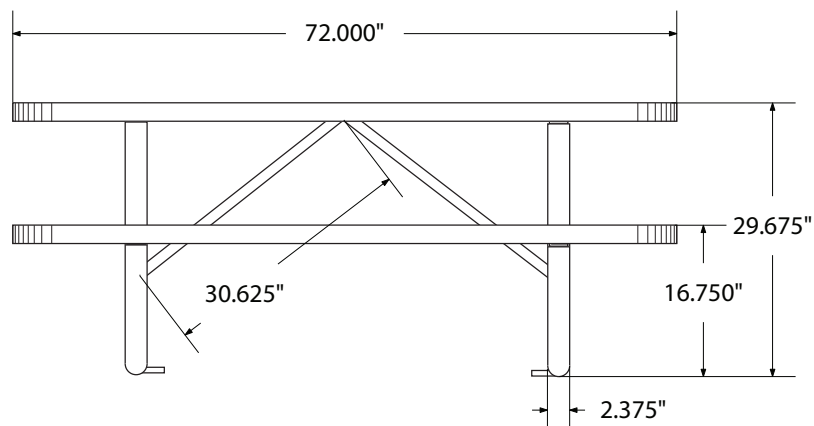

side view

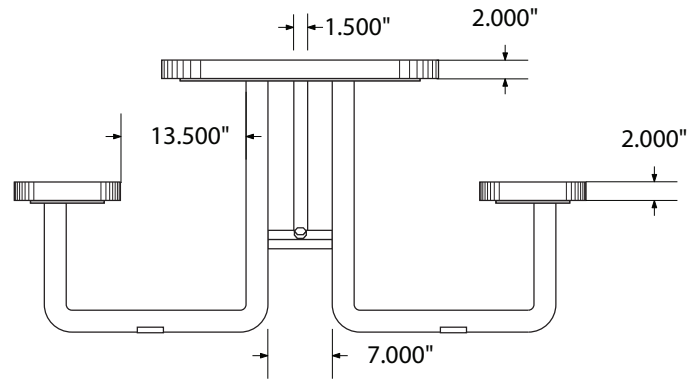

product details



Coated Surfaces:

- Thermoplastic coated
- Copolymer-based, environmentally safe
- Does not fade, crack, peel or warp
- Applied at a thickness of 25-30 mils.
- 5 Year warranty on coating



Construction:

- Seats and tops - 9 gauge steel
- 2 3/8" tubular understructure
- Understructure - galvanized steel
- Understructure finish - black polyester powder coated
- Nuts, washers and bolts - galvanized steel

mounting types

P = Portable : no mount

SM = Surface Mount:
concrete anchors
through discs welded
to legs

IG= In-Ground:
J-rods set in concrete
through discs welded
to legs

