

SPECS AND INSTALL INSTRUCTIONS

Commercial U-Leg Welded Wire Park Bench

SKU:

6' CF-HKNUC

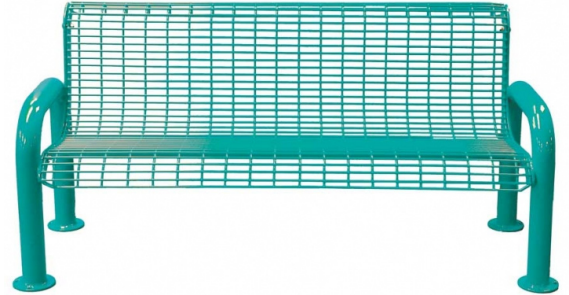

Thermoplastic Coating

Our outdoor furniture is covered in a copolymer-based thermoplastic powder coating. Thermoplastic is environmentally safe, the coating will never fade, crack, peel, warp, or discolor for the life of the product. Thermoplastic has the best adhesion rate of any other process. This keeps the metal base free of any corrosion possibilities. Thermoplastic is applied at a thickness of 25-30 mils. This allows maximum protection with the best possible surface. Thermoplastic can be easily repaired. Cuts are repaired by heating the affected area with an industrial heat gun. The thermoplastic will rebind itself. The properties of thermoplastic also make spray painting difficult for vandals. Simply wash product with a standard industrial cleaner.

Specifications





General

All of the listed products above are protected with Thermoplastic coating. Predrilled holes for surface mounting. Cast iron legs. Signature series customized benches have four optional areas for text and graphics.

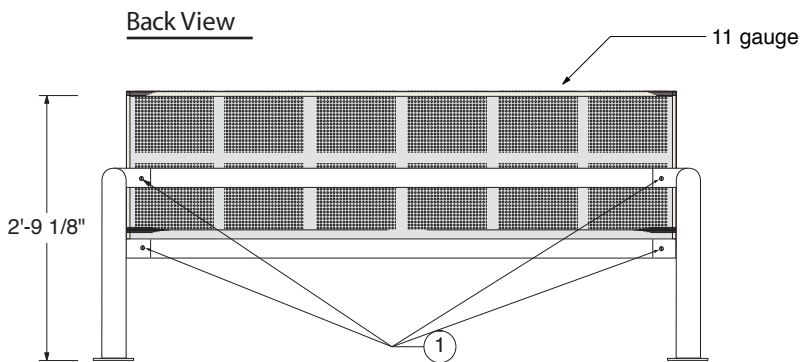
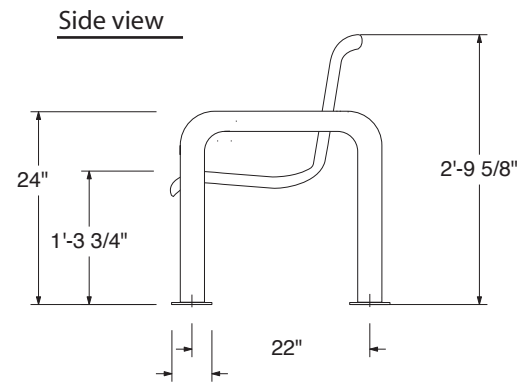
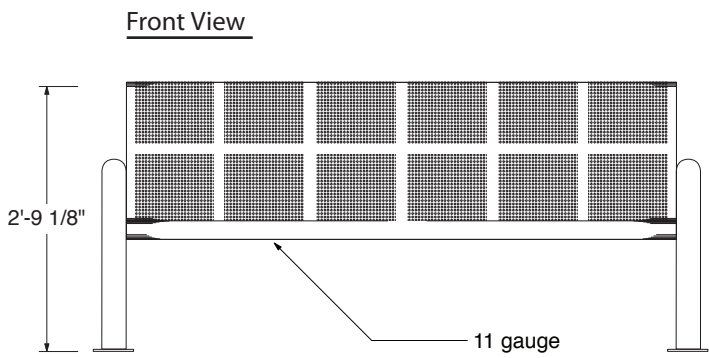
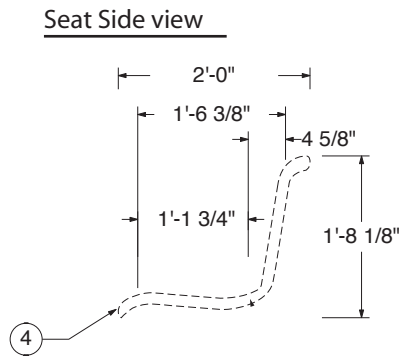
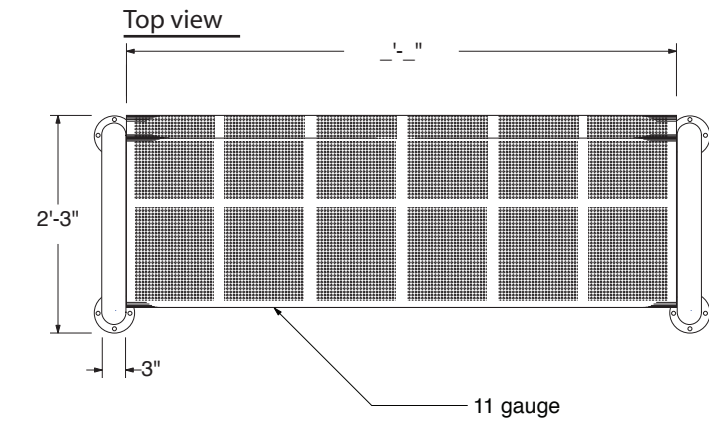
Check for any damaged or missing parts of if you have problems assembling your furniture / equipment please call our Customer Service Representatives.

Roll Formed Bench (Wire, Perforated)



Available Styles	Quantities (per bench)	Hardware
 Perforated  Wire	1A - Machine Bolt - qty 4 1B - 5/16" Washer - qty 4 1C - 5/16" Nut - qty 4 2 - Steel Bench Leg w/o Back - qty 2 3 - 11 Gage Steel Bench Seat w Back - qty 1 4 - Steel Bench Leg bar - qty 2	(A) 5/16" Machine head  (B) 5/16" Washer  (C) 5/16" Nut 

scale 1/2" = 1'



Roll Formed Bench without Back (Perforated, Expanded, Wire)

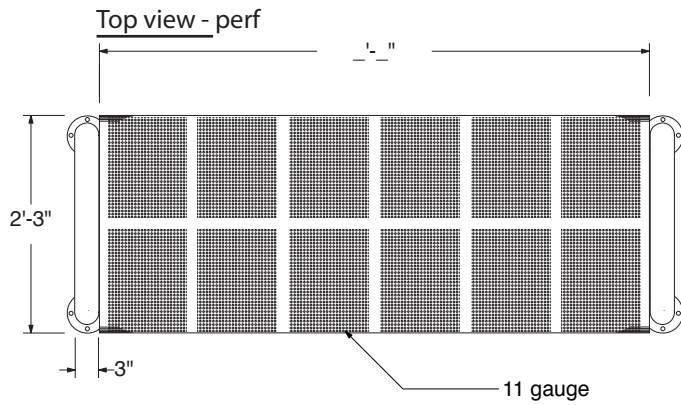

Seat Side view

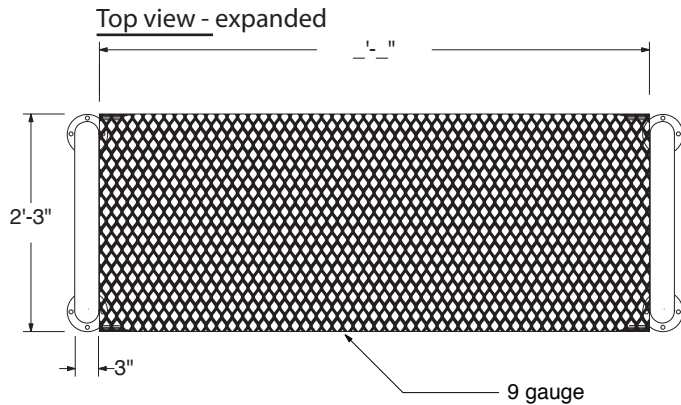
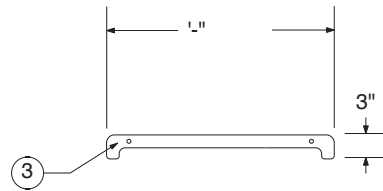

Seat Side view

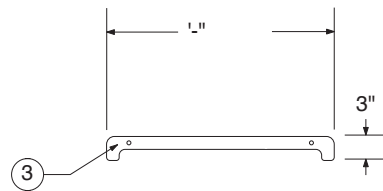

Front View - perf

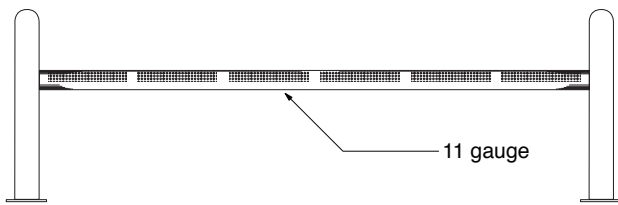

Side view

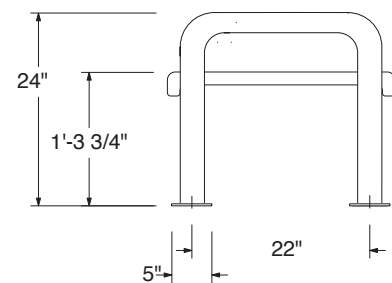

Front View - expanded

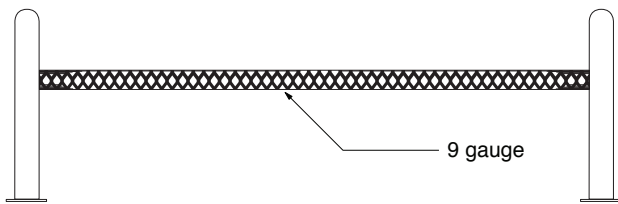



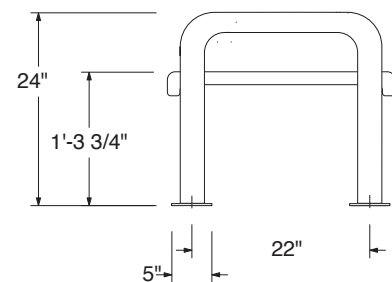



Side view



Available Styles

Quantities (per bench)

Hardware





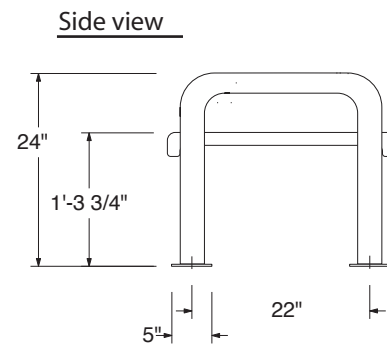
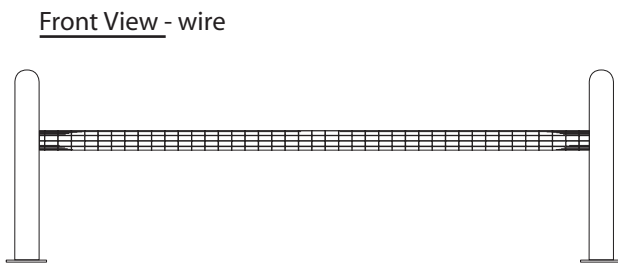
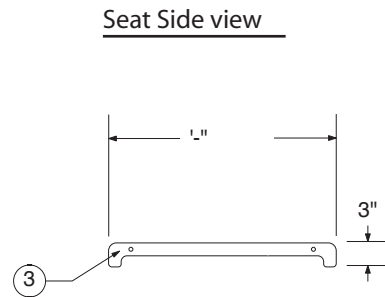
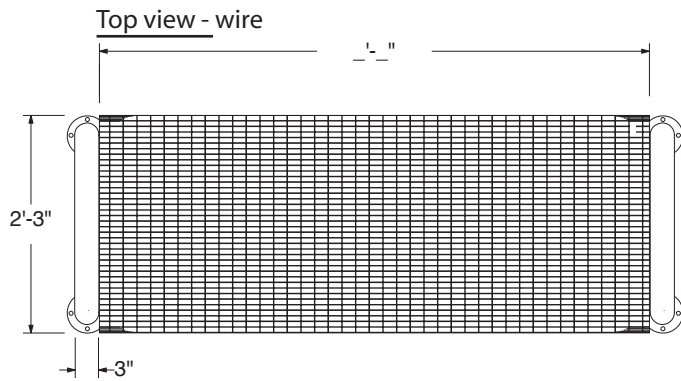

	Expanded Metal	1A - Machine Bolt - qty 4	
		1B - 5/16" Washer - qty 4	
		1C - 5/16" Nut - qty 4	
	Perforated	2 - Steel Bench Leg w/o Back - qty 2	
		3 - 11 Gage Steel Bench Seat w/o Back - qty 1	
		4 - Steel Bench Leg bars - qty 2	
	Wire		
			(A) 5/16" Machine head 
			(B) 5/16" Washer 
			(C) 5/16" Nut 

scale 1/2" = 1'



Roll Formed Bench without Back (Perforated, Expanded, Wire)



Available Styles	Quantities (per bench)	Hardware
 Expanded Metal	1A - Machine Bolt - qty 4 1B - 5/16" Washer - qty 4 1C - 5/16" Nut - qty 4	(A) 5/16" Machine head 
 Perforated	2 - Steel Bench Leg w/o Back - qty 2 3 - 11 Gage Steel Bench Seat w/o Back - qty 1 4 - Steel Bench Leg bars - qty 2	(B) 5/16" Washer 
 Wire		(C) 5/16" Nut 

scale 1/2" = 1'

